

**Tower Crane / Grue à tour / Gru a torre
Grúa torre / Guindaste de torre**

Turmdrehkran 63 LC

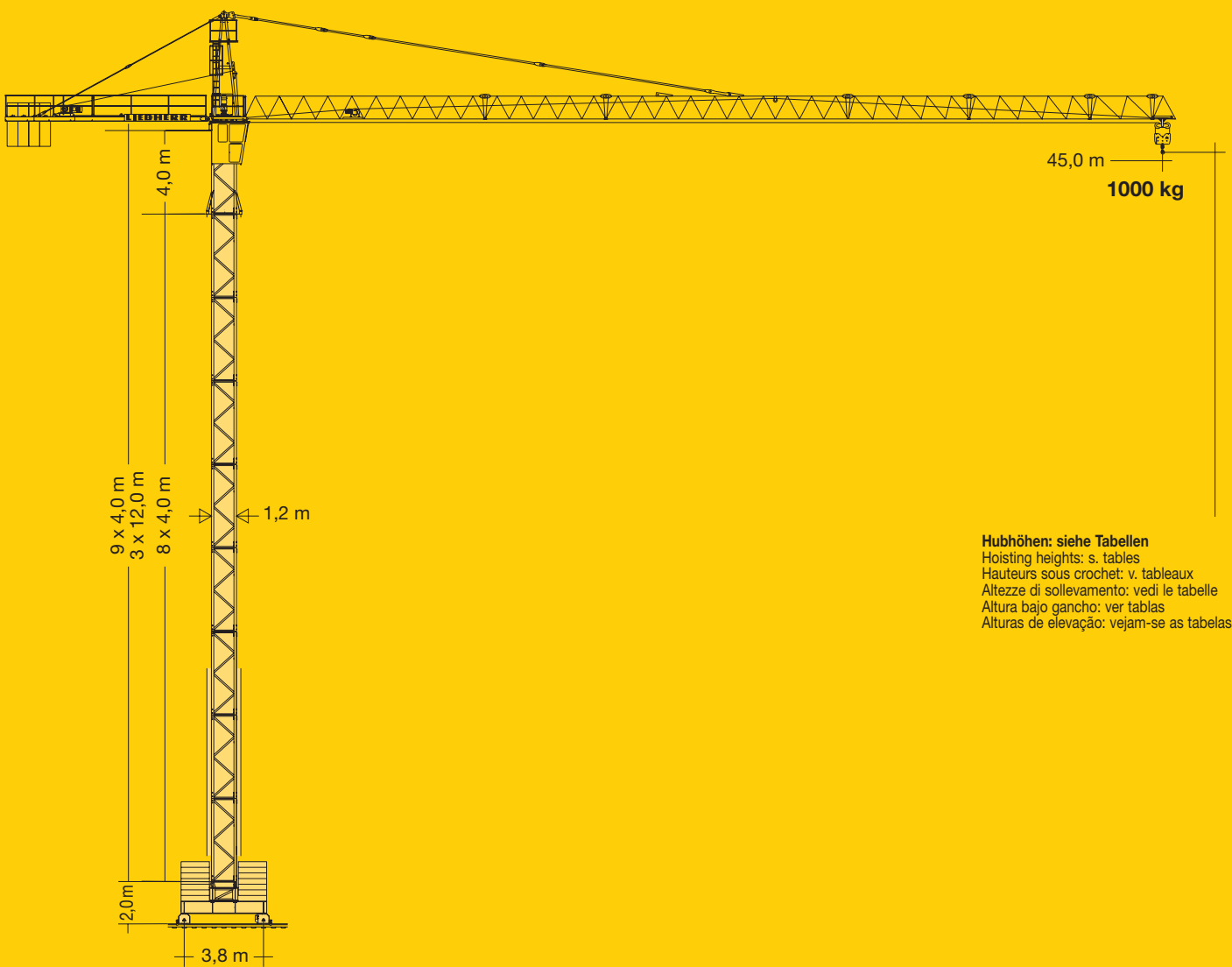

Hubhöhen: siehe Tabellen
Hoisting heights: s. tables
Hauteurs sous crochet: v. tableaux
Altezze di sollevamento: vedi le tabelle
Altura bajo gancho: ver tablas
Alturas de elevação: veja-se as tabelas

Turm 63 LC
tower / le mât
torre
max. 37,0 m

DIN/FEM

1 : 300

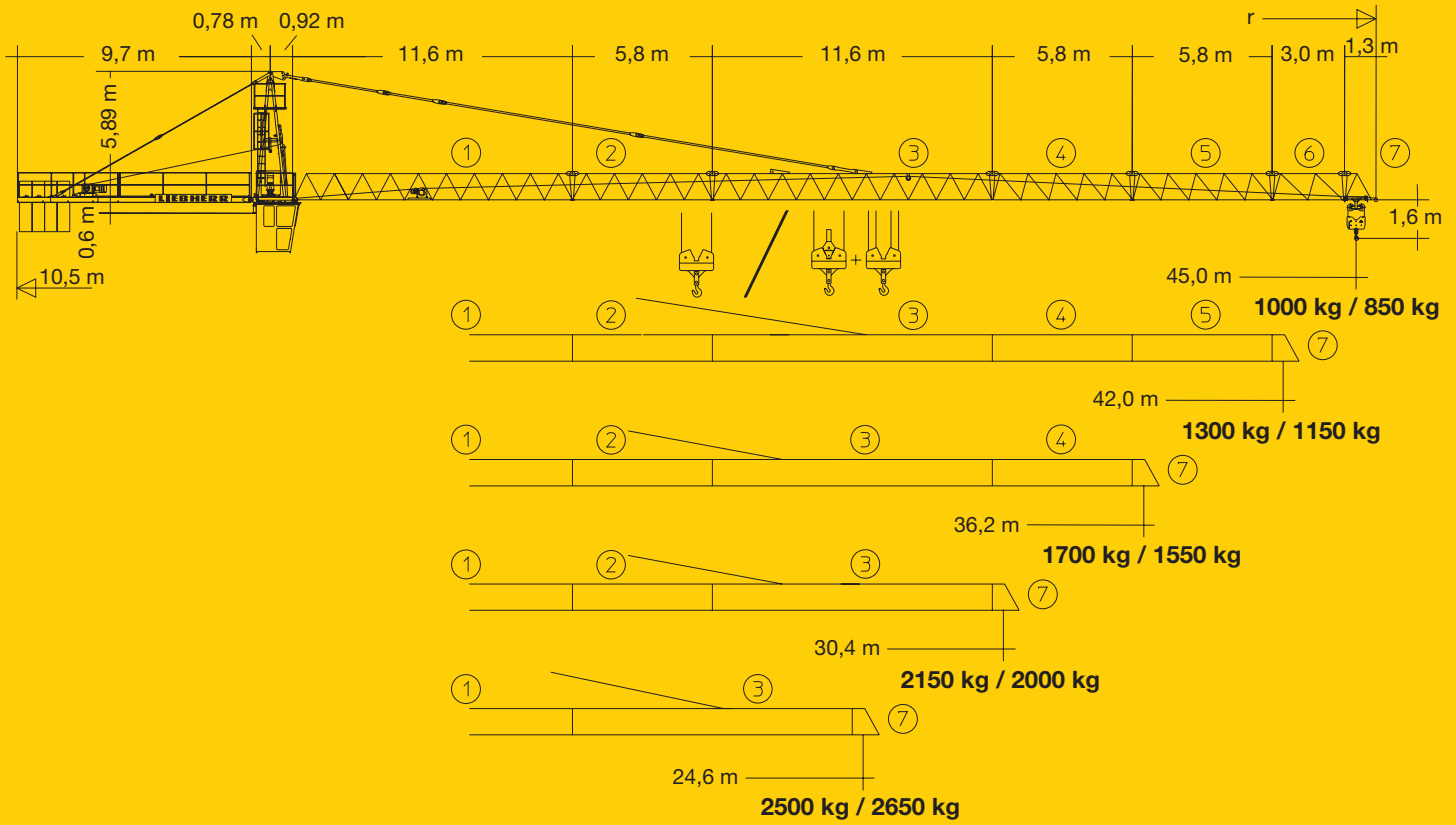

GD-1

LIEBHERR



Gewicht

Weight / Poids / Peso / Peso / Pesos

Zentralballast / Central ballast Lest de base / Zavorra centrale Lastro central / Lastre central	FEM: 40000 kg DIN: 50000 kg		(Ausl. 45 m)	9000 kg		19400 kg
--	--------------------------------	---	--------------	---------	---	----------

Hubhöhe

Hoisting height / Hauteur sous crochet / Altezza di sollevamento / Altura bajo gancho / Altura de montagem

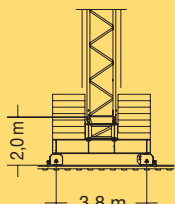
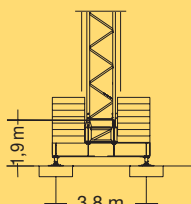
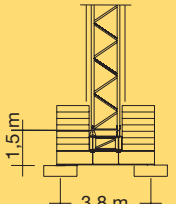
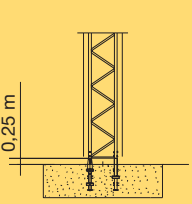
		63 LC			
4 m	12 m				
9*	3	37,0	36,9	36,5	35,3
8		33,0	32,9	32,5	31,3
7		29,0	28,9	28,5	27,3
6	2	25,0	24,9	24,5	23,3
5		21,0	20,9	20,5	19,3
4		17,0	16,9	16,5	15,3
3	1	13,0	12,9	12,5	11,3
2		9,0	8,9	8,5	7,3
1		5,0	4,9	4,5	3,3
		m	m	m	m
					
		2,0 m	1,9 m	1,5 m	0,25 m
		3,8 m	3,8 m	3,8 m	

* Weitere Hubhöhen auf Anfrage. / Further hoist heights on request. / Hauteurs sous crochet sur demande. / Altre altezze di sollevamento: su richiesta. / Outras alturas de elevação: conforme ao pedido. / Para alturas bajo gancho superiores, consultar.



Ausladung und Tragfähigkeit

Radius and capacity / Portée et charge / Sbraccio e portata / Alcances y cargas / Alcance e capacidade de carga

m	r	m/kg	m/kg													
			12,0	14,0	16,0	18,0	20,0	22,0	24,6	28,0	30,4	34,0	36,2	40,0	42,0	45,0
45,0	(r = 45,9)	2,1-20,6 2500					2500	2330	2050	1770	1610	1410	1310	1160	1090	1000
42,0	(r = 42,9)	2,1-23,8 2500					2500	2500	2410	2080	1900	1670	1550	1380	1300	
36,2	(r = 37,1)	2,1-25,7 2500					2500	2500	2500	2280	2080	1830	1700			
30,4	(r = 31,3)	2,1-26,6 2500					2500	2500	2500	2360	2150					
24,6	(r = 25,5)	2,1-24,6 2500					2500	2500	2500							

m	r	m/kg		m/kg													
		2,1-19,8 2500	2,1-10,9 5000	12,0	14,0	16,0	18,0	20,0	22,0	24,6	28,0	30,4	34,0	36,2	40,0	42,0	45,0
45,0	(r = 45,9)	2,1-19,8 2500	2,1-10,9 5000	4480	3760	3220	2800	2470	2200	1920	1630	1470	1260	1160	1010	940	850
42,0	(r = 42,9)	2,1-22,8 2500	2,1-12,5 5000	5000	4400	3780	3300	2920	2610	2280	1950	1760	1520	1400	1230	1150	
36,2	(r = 37,1)	2,1-24,5 2500	2,1-13,5 5000	5000	4790	4110	3600	3180	2850	2500	2140	1930	1680	1550			
30,4	(r = 31,3)	2,1-26,3 2500	2,1-13,8 5000	5000	4940	4250	3710	3290	2940	2580	2210	2000					
24,6	(r = 25,5)	2,1-24,6 2500	2,1-14,2 5000	5000	5000	4360	3810	3370	3020	2650							

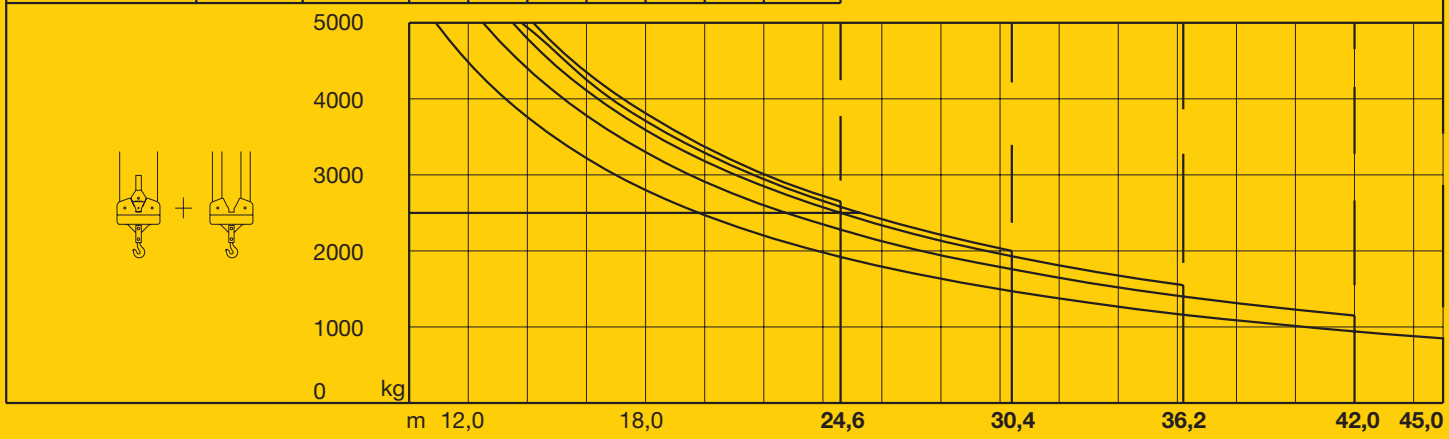

Geschwindigkeiten

Speeds / Vitesses / Velocità / Velocidades / Velocidades

	U/min 0 - 0,8 sl./min tr./min	3,0 kW
	19,0 / 38,0 m/min 21,0 / 42,0 m/min	1,0 / 1,8 kW 1,5 / 3,0 kW
	20,0 m/min	2 x 2,2 kW
	kVA	14,0 kW 18,5 kW 26,0 31,0

Stufe / Step Cran / Marcia / Marcha / Marcha	kg	m/min
	4,6 / 14,0 / 14,0 kW	2 Lagen Layers Couches strati camadas capas
	2500	8,0
	2500	28,0
	1300	56,0
	119,0 m mit LS-Trommel	7 Lagen Layers Couches strati camadas capas
	5000	4,0
	5000	14,0
	2400	28,0
	3,7 / 18,5 / 18,5 kW	6 Lagen Layers Couches strati camadas capas
	2500	7,0
	2500	33,0
	1300	65,0
	5000	3,5
	5000	16,5
	2500	32,5

CD-



































Technische Daten

Technical data - Caractéristiques techniques
Caratteristiche tecniche - Características técnicas - Datos técnicos

Kolli-Liste

Packing List / Liste de colisage / Lista dei colli
Lista de embalagem / Lista de dimensiones y pesos

Montagegewichte: siehe Betriebsanweisung.
Erection weights: see instruction manual.
Poids de montage: voir manuel de service.
Pesi di montaggio: vedasi le istruzioni sull'uso.
Pesos de montaje: vejam-se as instruções p. uso.
Peso para el montaje: según manual.

Kranoberteil		Upper part of crane / Partie supérieure de gru Parte superiore della gru / Parte superior grúa Parte superior do guindaste	L (m)	B (m)	H (m)	kg	Einzelgewichte / Single weights / Poids individuels. Pesi di componenti. Pesos de peças componentes. Pesos unitarios.	
Pos. Item Rep. Voce Ref. Pos.	Anz. Qty. Qta. Quant. Cant.							
1	1	Kabine + Steuerstand / Cabin + Seat Cabine + fauteuil / Cabina + poltrona Cabine + cadeira / Cabina + butaca			1,87	1,12	2,18	440
2	1	Turmspitze mit Kud-Auflage Tower head section with slewing ring support Porte-flèche avec pivot / Testa porta-braccio Cabeça de apoio de lança / Cabeza de torre			5,57	1,86	1,73	2530
3	1	Gegenausleger / Counter-jib Contre-flèche / Contrabaccio Contra-lança / Contrapluma			9,79	1,46	0,36	960
4	1	Ausleger-Anlenkstück / Jib heel section Pied de flèche / Settore articolato di braccio Base articulada de lança / Pluma tramo primero			11,85	1,04	1,30	① 1070
5	1	Ausleger-Zwischenstück / Intermediate jib section Elément interm. de flèche / Spezzone di braccio Peça suplementar da lança / Tramo intermedio pluma			5,94 11,80 5,94 3,18	0,95 0,95 0,95 0,95	1,22 1,32 1,22 1,22	② 401 ③ 810 ④ 261 ⑤ 210 ⑥ 111
6	1	Ausleger-Kopfstück / Jib head Pointe de flèche / Punta freccia Cabeça de lança / Tramo punta de pluma			1,45	1,04	1,37	80
7	1	Podeste / Platforms Plates-formes / Plattforma Plataforma / Plataforma			1,90	0,35	1,60	160
8	1	Laufkatze / Trolley Chariot / Carrello Carrinho / Carrito			0,95	1,13	0,62	151
9	1	Unterflasche / Bottom Moufle / Bozzello Gancha / Potipasto			0,75	0,24	0,98	104
10	1	Hubwerk 14 kW / Winch Treuil / Argano / Mecanismo elevatoria / Mecanismo elevación carga			1,25	1,23	0,55	450
Turm		Tower / Mât / Torre Torre / Torre						
11	1	Turmstück / Tower section Element de mât / Elemento di torre Torre / Torre			12 m 4 m	12,27 4,27	1,20 1,30	2435 958
Klettereinrichtung		Climbing equipment / Equipement de télescopage / Attrezzatura per allungamento della gru Acessórios p. subida no edifício / Equipo de trepado						
12	1	Führungsstück kpl. / Guide section cpl. Cage télescopique cpl. / Gabbia di sopraelevazione compl. Peça de guia compl. / Torre de montaje completa			8,92	1,65	1,75	1890
13	1	Führungsstück Turmstück / Tower guide section Élément de mât télescopique / Gabbia di sopraelevazione Peca de guia / Tramo torre de montaje			4,27	1,66	1,66	1120
14	1	Hydraulikanlage, Stütz- und Klettertraverse / Hydraulic unit, supporting and climbing cross members Système hydraul. avec traverses d'appui et de télescop. / Sist. idraul., traversa di appoggio e allugam. gru Instalação hidráulica, travessa de apoio e subida / Sistema hidráulico com travessa de apoio y trepado			4,86	0,95	0,70	580
Unterwagen		Undercarriage / Châssis / Carro della gru Carro de guindaste / Carro con mástil						
15	1	Unterwagen-Rahmen / Undercarriage frame Cadre de châssis / Intelaiatura carro Estrutura do carrinho / Bastidor carretón			4,12	0,94	1,39	2575
16	2	Tragholm / Arm Longeron / Longherone Travessa / Brazo			4,10	0,30	0,60	935
17	2	Fahrschemel mit Antrieb / Rail bogie with drive Bogie moteur / Telajo con gruppia propulsore Quadra sem grupa de propulsão / Caja rodillo matriz			0,78	0,84	0,53	297
18	2	Fahrschemel ohne Antrieb / Rail bogie without drive Bogie fou / Telajo senza gruppia propulsore Quadra com grupa de propulsão / Caja rodillo conducido			0,66	0,30	0,51	204
19	1	Seile und Kleinteile / Small parts and ropes Accessoire et câbles / Accessori cavi Accesorios e cabos / Accesorios y cables			-	-	-	1300

120 P – 3635 H1 B3 DIN 15018 • BGL 2125-0063 / FEM (Section 1) Krangruppe A3 • 01.2000 / 6

Konstruktionsänderungen vorbehalten! / Subject to alterations!
Sous réserves de modifications! / Si fa riserva di modifiche!
Salvo modificação da construação! / ¡Sujeto a modificaciones!

Printed in Germany.

